



# SPECIFICATION

Release date: February 12, 2020 - V.1.0

# SPECIFICATION

## MECHANICAL & ELECTRICAL CHARACTERISTICS

Working Current	Static current: 300mA/14.5V
	Dynamic current: 600mA/14.5V
	Locked motor current: 3.5A/14.5V
Operating Temperature	32° F ~ 120° F (0° C ~ 50° C)
Weight	2.65 lbs (1200 g)
Gimbal Dimension	237(W) x 184(D) x 288(H)

## PERIPHERAL

Camera Tray Dimensions	Maximum depth from the center of gravity on camera base plate: 100mm
	Maximum height measured from top of camera base plate: 120mm
	Maximum width: 152mm
Input Power	15-52V
Connections	USB 2.0, CAN, UART, S-bus, Spektrum, PPM, Bluetooth
PC Assistant Software Requirements	Windows XP or above; Mac OS X 10.9 or above
Mobile Assistant Software Requirements	iOS 7.1 or above; Android 4.3 or above







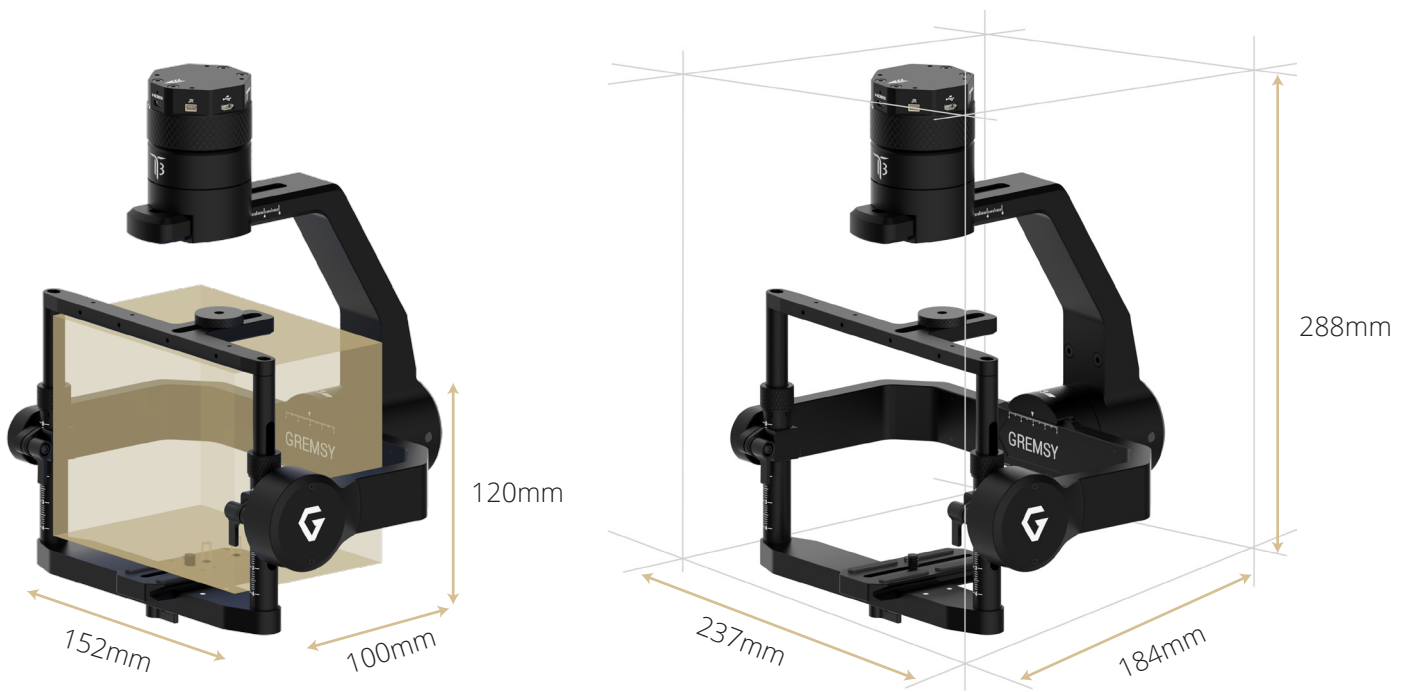





## WORKING PERFORMANCE

Maximum Payload	3.7 lbs (1700g)
Angular Vibration Range	± 0.02°
Maximum Controlled Rotation Speed	Pan axis: 180°/s
	Tilt axis: 180°/s
	Roll axis: 180°/s
Mechanical Endpoint Range	Pan axis control: ±345°
	Tilt axis control: ±150°
	Roll axis control: +80° to -264°
Controlled Rotation Range	Pan axis control: ±345°
	Tilt axis control: ±120°
	Roll axis control: ± 45°

## DIMENSION & CAMERA CAGE



## CAMERA COMPATIBILITY

 <p>Wiris</p>	 <p>Panasonic GH3, GH4, GH5</p>	 <p>Canon 6D Mk I, Mk II</p>	 <p>Pentax</p>
 <p>Sony Alpha A9 (I - II)</p>	 <p>Sony A6000, A6300, A6500</p>	 <p>Sony A7S (mk I - II)</p>	 <p>Sony A7r (mk I - IV)</p>
 <p>Nikon D810, D800, D500</p>	 <p>Phase One iXM50/100</p>	 <p>UMC-S3CA</p>	 <p>FUJIFILM X-T</p>

For more information, visit our website at: [gremsy.com](https://gremsy.com)

For instant support, send us an email to [contact@gremsy.com](mailto:contact@gremsy.com)



[@GREMSYTECH](https://www.instagram.com/GREMSYTECH)



[FACEBOOK.COM/GREMSY](https://www.facebook.com/GREMSY)



[GREMSY.COM](https://www.gremsy.com)